



0. Quantum
Compiler

I. Quantum
Information

II. Quantum Control

III. Local Control

Conclusions &
Outlook

Quantum Computing as an Engineering Problem: An Optimal-Control-Based Quantum Compiler

Thomas Schulte-Herbrüggen

Technical University Munich, TUM

Seminar “Pearls in Computer Science”, TUM, April 2007

Motivation: Control in Quantum Technology

*We are currently in the midst of **a second quantum revolution**. The first quantum revolution gave us new rules that govern physical reality. The second quantum revolution will take these rules and use them to develop **new technologies**.* DOWLING & MILBURN, 2003

0. Quantum Compiler

I. Quantum Information

II. Quantum Control

III. Local Control

Conclusions & Outlook

- economy

currently some 30% of the GNP of industrial states depend on quantum effects (transistor, laser)

- technology ahead

quantum & nano-technology rely on **quantum control**
(solid-state devices, spintronics–NMR–EPR, quantum dots, ion-traps)

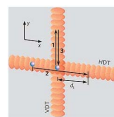
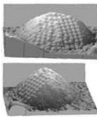
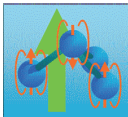

Motivation: Control in Quantum Technology

*We are currently in the midst of a **second quantum revolution**. The first quantum revolution gave us new rules that govern physical reality. The second quantum revolution will take these rules and use them to develop **new technologies**.* DOWLING & MILBURN, 2003

0. Quantum Compiler

I. Quantum Information

II. Quantum Control

III. Local Control

Conclusions & Outlook

- **economy**

currently some 30% of the GNP of industrial states depend on quantum effects (transistor, laser)

- **technology ahead**

quantum & nano-technology rely on **quantum control**
(solid-state devices, spintronics–NMR–EPR, quantum dots, ion-traps)

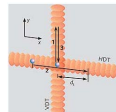
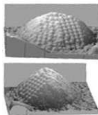
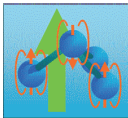



Classical Compiler

Compilation into Machine Code

0. Quantum Compiler

I. Quantum Information

II. Quantum Control

III. Local Control

Conclusions & Outlook

■ Classical Compilation

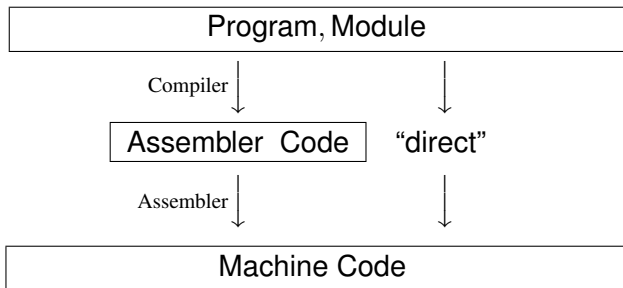



Quantum Compiler

Compilation into Machine Code of Quantum Controls

0. Quantum Compiler

I. Quantum Information

II. Quantum Control

III. Local Control

Conclusions & Outlook

■ Quantum Compilation: a Control Problem

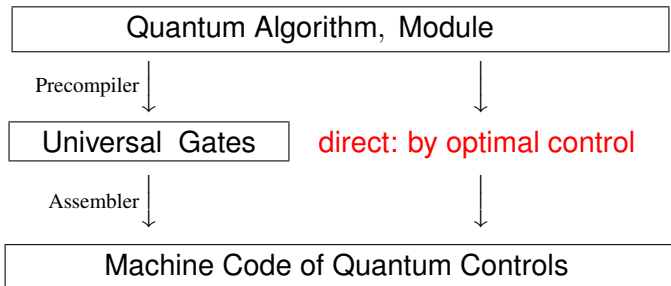

crucial for quantum machine code:
has to be timeoptimal or decoherence protected



Quantum Compiler

Compilation into Machine Code of Quantum Controls

0. Quantum Compiler

I. Quantum Information

II. Quantum Control

III. Local Control

Conclusions & Outlook

■ Quantum Compilation: a Control Problem

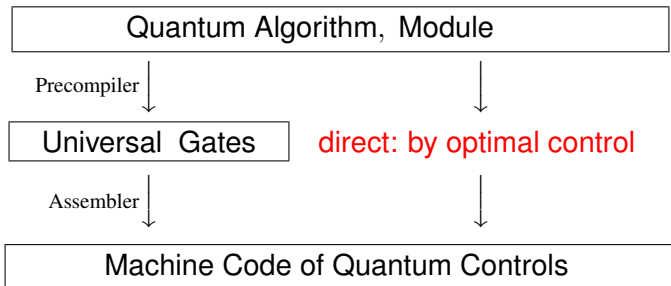

crucial for **quantum** machine code:

has to be **timeoptimal** or **decoherence protected**



Outline

0. Quantum Compiler

I. Quantum Information

II. Quantum Control

III. Local Control

Conclusions & Outlook

- 1 Quantum Compilation
- 2 First Glimpses into the Quantum World
 - Quantum Basics
 - Quantum Computing
- 3 Quantum Compilation by Optimal Control
 - Principles and Tasks
 - Gradient-Flow Algorithms
 - Timeoptimal Control
 - Decoherence Control
- 4 Local Control
- 5 Conclusions & Outlook



What is Special with Quantum Systems?

0. Quantum Compiler

I. Quantum Information

Quantum Basics
Quantum Computing

II. Quantum Control

III. Local Control

Conclusions & Outlook

Fascinating Fact: unparalleled in classical physics

Theorem

*Generically, a multi-partite quantum system contains **more information** than is accessible from piecing together the information of its components.*

Corollary

“The total is more than the sum of its constituent pieces.”



What is Special with Quantum Systems?

0. Quantum Compiler

I. Quantum Information

Quantum Basics
Quantum Computing

II. Quantum Control

III. Local Control

Conclusions & Outlook

Fascinating Fact: unparalleled in classical physics

Theorem

*Generically, a multi-partite quantum system contains **more information** than is accessible from piecing together the information of its components.*

Corollary

“The total is more than the sum of its constituent pieces.”



Quantum Systems – Basic Notions and Notations: “Qubits”

0. Quantum
Compiler

I. Quantum
Information

Quantum Basics
Quantum Computing

II. Quantum Control

III. Local Control

Conclusions &
Outlook

- 1 representation:** *pure* quantum states are represented by vectors, e.g. in a two-level system
 $|0\rangle := \begin{pmatrix} 1 \\ 0 \end{pmatrix} \in \mathbb{C}^2$ and $|1\rangle := \begin{pmatrix} 0 \\ 1 \end{pmatrix} \in \mathbb{C}^2$
- 2 superposition:** linear combinations give new states
 $\cos \phi |0\rangle + \sin \phi |1\rangle$
- 3 composition:** take tensor product of constituents
 $|01\rangle := \begin{pmatrix} 1 \\ 0 \end{pmatrix} \otimes \begin{pmatrix} 0 \\ 1 \end{pmatrix} = (0, 1, 0, 0)^t \in \mathbb{C}^4$
- 4** the state space forms a **Hilbert space**,
in which the basis $\{|0\rangle, |1\rangle\}$ is orthonormal
 $\langle 0|1\rangle = \langle 1|0\rangle = 0$ (where $\langle 0| := (10)$)
 $\langle 0|0\rangle = \langle 1|1\rangle = 1$ (note $|0\rangle\langle 0| := (10)^t(10) = \begin{pmatrix} 1 & 0 \\ 0 & 0 \end{pmatrix}$)
- 5 general quantum states:** combine dyadic products

$$\rho = \sum_{ij} \lambda_{ij} |\psi_i\rangle\langle\psi_j|$$

with $\lambda_{ij} = \lambda_{ji}^*$ and $\text{tr } \rho = \sum_j \lambda_{jj} = 1$ and $\rho \geq 0$



Quantum Systems – Basic Notions and Notations: “Qubits”

0. Quantum
Compiler

I. Quantum
Information

Quantum Basics
Quantum Computing

II. Quantum Control

III. Local Control

Conclusions &
Outlook

- 1 representation:** *pure* quantum states are represented by vectors, e.g. in a two-level system
 $|0\rangle := \begin{pmatrix} 1 \\ 0 \end{pmatrix} \in \mathbb{C}^2$ and $|1\rangle := \begin{pmatrix} 0 \\ 1 \end{pmatrix} \in \mathbb{C}^2$
- 2 superposition:** linear combinations give new states
 $\cos \phi |0\rangle + \sin \phi |1\rangle$
- 3 composition:** take tensor product of constituents
 $|01\rangle := \begin{pmatrix} 1 \\ 0 \end{pmatrix} \otimes \begin{pmatrix} 0 \\ 1 \end{pmatrix} = (0, 1, 0, 0)^t \in \mathbb{C}^4$
- 4** the state space forms a **Hilbert space**, in which the basis $\{|0\rangle, |1\rangle\}$ is orthonormal
 $\langle 0|1\rangle = \langle 1|0\rangle = 0$ (where $\langle 0| := (10)$)
 $\langle 0|0\rangle = \langle 1|1\rangle = 1$ (note $|0\rangle\langle 0| := (10)^t(10) = \begin{pmatrix} 1 & 0 \\ 0 & 0 \end{pmatrix}$)
- 5 general quantum states:** combine dyadic products

$$\rho = \sum_{ij} \lambda_{ij} |\psi_i\rangle\langle\psi_j|$$

with $\lambda_{ij} = \lambda_{ji}^*$ and $\text{tr } \rho = \sum_j \lambda_{jj} = 1$ and $\rho \geq 0$



Quantum Systems – Basic Notions and Notations: “Qubits”

0. Quantum
Compiler

I. Quantum
Information

Quantum Basics
Quantum Computing

II. Quantum Control

III. Local Control

Conclusions &
Outlook

- 1 representation:** *pure* quantum states are represented by vectors, e.g. in a two-level system
 $|0\rangle := \begin{pmatrix} 1 \\ 0 \end{pmatrix} \in \mathbb{C}^2$ and $|1\rangle := \begin{pmatrix} 0 \\ 1 \end{pmatrix} \in \mathbb{C}^2$
- 2 superposition:** linear combinations give new states
 $\cos \phi |0\rangle + \sin \phi |1\rangle$
- 3 composition:** take tensor product of constituents
 $|01\rangle := \begin{pmatrix} 1 \\ 0 \end{pmatrix} \otimes \begin{pmatrix} 0 \\ 1 \end{pmatrix} = (0, 1, 0, 0)^t \in \mathbb{C}^4$
- 4** the state space forms a **Hilbert space**,
in which the basis $\{|0\rangle, |1\rangle\}$ is orthonormal
 $\langle 0|1\rangle = \langle 1|0\rangle = 0$ (where $\langle 0| := (10)$)
 $\langle 0|0\rangle = \langle 1|1\rangle = 1$ (note $|0\rangle\langle 0| := (10)^t(10) = \begin{pmatrix} 1 & 0 \\ 0 & 0 \end{pmatrix}$)
- 5 general quantum states:** combine dyadic products

$$\rho = \sum_{ij} \lambda_{ij} |\psi_i\rangle\langle\psi_j|$$

with $\lambda_{ij} = \lambda_{ji}^*$ and $\text{tr } \rho = \sum_j \lambda_{jj} = 1$ and $\rho \geq 0$



Quantum Systems – Basic Notions and Notations: “Qubits”

0. Quantum
Compiler

I. Quantum
Information

Quantum Basics
Quantum Computing

II. Quantum Control

III. Local Control

Conclusions &
Outlook

- 1 representation:** *pure* quantum states are represented by vectors, e.g. in a two-level system
 $|0\rangle := \begin{pmatrix} 1 \\ 0 \end{pmatrix} \in \mathbb{C}^2$ and $|1\rangle := \begin{pmatrix} 0 \\ 1 \end{pmatrix} \in \mathbb{C}^2$
- 2 superposition:** linear combinations give new states
 $\cos \phi |0\rangle + \sin \phi |1\rangle$
- 3 composition:** take tensor product of constituents
 $|01\rangle := \begin{pmatrix} 1 \\ 0 \end{pmatrix} \otimes \begin{pmatrix} 0 \\ 1 \end{pmatrix} = (0, 1, 0, 0)^t \in \mathbb{C}^4$
- 4** the state space forms a **Hilbert space**,
in which the basis $\{|0\rangle, |1\rangle\}$ is orthonormal
 $\langle 0|1\rangle = \langle 1|0\rangle = 0$ (where $\langle 0| := (10)$)
 $\langle 0|0\rangle = \langle 1|1\rangle = 1$ (note $|0\rangle\langle 0| := (10)^t(10) = \begin{pmatrix} 1 & 0 \\ 0 & 0 \end{pmatrix}$)
- 5 general quantum states:** combine dyadic products

$$\rho = \sum_{ij} \lambda_{ij} |\psi_i\rangle\langle\psi_j|$$

with $\lambda_{ij} = \lambda_{ji}^*$ and $\text{tr } \rho = \sum_j \lambda_{jj} = 1$ and $\rho \geq 0$



Quantum Systems – Basic Notions and Notations: “Qubits”

0. Quantum
Compiler

I. Quantum
Information

Quantum Basics
Quantum Computing

II. Quantum Control

III. Local Control

Conclusions &
Outlook

- 1 representation:** *pure* quantum states are represented by vectors, e.g. in a two-level system
 $|0\rangle := \begin{pmatrix} 1 \\ 0 \end{pmatrix} \in \mathbb{C}^2$ and $|1\rangle := \begin{pmatrix} 0 \\ 1 \end{pmatrix} \in \mathbb{C}^2$
- 2 superposition:** linear combinations give new states
 $\cos \phi |0\rangle + \sin \phi |1\rangle$
- 3 composition:** take tensor product of constituents
 $|01\rangle := \begin{pmatrix} 1 \\ 0 \end{pmatrix} \otimes \begin{pmatrix} 0 \\ 1 \end{pmatrix} = (0, 1, 0, 0)^t \in \mathbb{C}^4$
- 4** the state space forms a **Hilbert space**,
in which the basis $\{|0\rangle, |1\rangle\}$ is orthonormal
 $\langle 0|1\rangle = \langle 1|0\rangle = 0$ (where $\langle 0| := (10)$)
 $\langle 0|0\rangle = \langle 1|1\rangle = 1$ (note $|0\rangle\langle 0| := (10)^t(10) = \begin{pmatrix} 1 & 0 \\ 0 & 0 \end{pmatrix}$)
- 5 general quantum states:** combine dyadic products

$$\rho = \sum_{ij} \lambda_{ij} |\psi_i\rangle\langle\psi_j|$$

with $\lambda_{ij} = \lambda_{ji}^*$ and $\text{tr } \rho = \sum_j \lambda_{jj} = 1$ and $\rho \geq 0$



Information Content of Quantum Systems

0. Quantum Compiler

I. Quantum Information

Quantum Basics

Quantum Computing

II. Quantum Control

III. Local Control

Conclusions & Outlook

Example

Consider the Bell state $|\Phi\rangle := \frac{1}{\sqrt{2}}(|00\rangle + |11\rangle)$:

$$\rho_{ab} = |\Phi\rangle\langle\Phi| = \frac{1}{2}(|00\rangle + |11\rangle)(\langle 00| + \langle 11|) \quad \text{(total info)}$$

$$\rho_a = \text{tr}_b |\Phi\rangle\langle\Phi| \quad \text{(local info a)}$$

$$= \frac{1}{2} \text{tr}_b (|00\rangle\langle 00| + |00\rangle\langle 11| + |11\rangle\langle 00| + |11\rangle\langle 11|)$$

$$= \frac{1}{2} (|0\rangle\langle 0|_a \langle 0|_b \langle 0|_b + |0\rangle\langle 1|_a \langle 1|_b \langle 0|_b + |1\rangle\langle 0|_a \langle 0|_b \langle 1|_b + |1\rangle\langle 1|_a \langle 1|_b \langle 1|_b)$$

$$= \frac{1}{2} (|0\rangle\langle 0|_a + |1\rangle\langle 1|_a)$$

$$= \frac{1}{2} \mathbf{1}_a$$

$$\rho_b = \text{tr}_a |\Phi\rangle\langle\Phi| = \frac{1}{2} \mathbf{1}_b \quad \text{(local info b)}$$



Quantum Information:

"The Total is More than the Sum of its Constituent Pieces"

0. Quantum Compiler

I. Quantum Information

Quantum Basics
Quantum Computing

II. Quantum Control

III. Local Control

Conclusions & Outlook

Proof (simplification).

The Example is generic: compare its information content

- 1 $\rho_{ab} = \rho_{ab}^2$ contains *all information* about **total system**;
- 2 $\rho_{a(b)}$ contains all information about **subsystems $a(b)$** ;
- 3 **reconstruction** $\rho'_{ab} := \rho_a \otimes \rho_b \neq \rho_{ab}^2$ puts together *all information accessible from both local subsystems*;
this is generically less than in ρ_{ab} .





Quantum Information:

"The Total is More than the Sum of its Constituent Pieces"

0. Quantum Compiler

I. Quantum Information

Quantum Basics
Quantum Computing

II. Quantum Control

III. Local Control

Conclusions & Outlook

Proof (simplification).

The Example is generic: compare its information content

- 1 $\rho_{ab} = \rho_{ab}^2$ contains *all information* about **total system**;
- 2 $\rho_{a(b)}$ contains all information about *subsystems* $a(b)$;
- 3 *reconstruction* $\rho'_{ab} := \rho_a \otimes \rho_b \neq \rho_{ab}^2$ puts together *all information accessible from both local subsystems*;
this is generically less than in ρ_{ab} .





Quantum Information:

"The Total is More than the Sum of its Constituent Pieces"

0. Quantum Compiler

I. Quantum Information

Quantum Basics
Quantum Computing

II. Quantum Control

III. Local Control

Conclusions & Outlook

Proof (simplification).

The Example is generic: compare its information content

- 1 $\rho_{ab} = \rho_{ab}^2$ contains *all information* about **total system**;
- 2 $\rho_{a(b)}$ contains all information about **subsystems $a(b)$** ;
- 3 **reconstruction** $\rho'_{ab} := \rho_a \otimes \rho_b \neq \rho_{ab}^2$ puts together *all information accessible from both local subsystems*;
this is generically less than in ρ_{ab} .





Quantum Information:

"The Total is More than the Sum of its Constituent Pieces"

0. Quantum Compiler

I. Quantum Information

Quantum Basics
Quantum Computing

II. Quantum Control

III. Local Control

Conclusions & Outlook

Proof (simplification).

The Example is generic: compare its information content

- 1 $\rho_{ab} = \rho_{ab}^2$ contains *all information* about **total system**;
- 2 $\rho_{a(b)}$ contains all information about **subsystems $a(b)$** ;
- 3 **reconstruction** $\rho'_{ab} := \rho_a \otimes \rho_b \neq \rho_{ab}^2$ puts together *all information accessible from both local subsystems*;
this is generically less than in ρ_{ab} .





Quantum Information:

"The Total is More than the Sum of its Constituent Pieces"

0. Quantum Compiler

I. Quantum Information

Quantum Basics
Quantum Computing

II. Quantum Control

III. Local Control

Conclusions & Outlook

Proof (simplification).

The Example is generic: compare its information content

- 1 $\rho_{ab} = \rho_{ab}^2$ contains *all information* about **total system**;
- 2 $\rho_{a(b)}$ contains all information about **subsystems** $a(b)$;
- 3 **reconstruction** $\rho'_{ab} := \rho_a \otimes \rho_b \neq \rho_{ab}^2$ puts together *all information accessible from both local subsystems*;
this is generically less than in ρ_{ab} .



Remark: The reconstruction $\rho'_{ab} = \rho_a \otimes \rho_b = \frac{1}{4} \mathbb{1}$ is *diagonal*, whereas the original $\rho_{ab} = \sum_{\mu\nu} \lambda_{\mu\nu} (|a_\mu\rangle\langle a_\nu| \otimes |b_\mu\rangle\langle b_\nu|)$ contained *off-diagonal* terms. The **coherent phase relation** between the local constituents cannot be reconstructed *a posteriori* from *local* pieces of information.



Quantum Information: Entanglement

0. Quantum
Compiler

I. Quantum
Information

Quantum Basics
Quantum Computing

II. Quantum Control

III. Local Control

Conclusions &
Outlook

Definition (Pure-State Entanglement)

An n -party pure quantum state that can be written as a **tensor product**

$$|\psi\rangle = |\psi_1\rangle \otimes |\psi_2\rangle \otimes \cdots \otimes |\psi_n\rangle$$

is called **product state**. If it cannot, it is called **entangled**.

Corollary

*Product states contain no more than local information, while **entangled states comprise more information than locally reconstructable**.*



Quantum Information: Entanglement

0. Quantum
Compiler

I. Quantum
Information

Quantum Basics
Quantum Computing

II. Quantum Control

III. Local Control

Conclusions &
Outlook

Definition (Pure-State Entanglement)

An n -party pure quantum state that can be written as a **tensor product**

$$|\psi\rangle = |\psi_1\rangle \otimes |\psi_2\rangle \otimes \cdots \otimes |\psi_n\rangle$$

is called **product state**. If it cannot, it is called **entangled**.

Corollary

*Product states contain no more than local information, while **entangled states comprise more information than locally reconstructable**.*



Quantum Systems – as a New Computational Resource

Principle: for cracking a black box in one shot

- input : product of superpositions
- output: superposition of products (entangled)

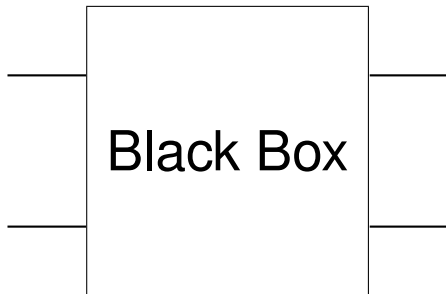

0. Quantum
Compiler

I. Quantum
Information

Quantum Basics
Quantum Computing

II. Quantum Control

III. Local Control

Conclusions &
Outlook



Quantum Systems – as a New Computational Resource

0. Quantum
Compiler

I. Quantum
Information

Quantum Basics
Quantum Computing

II. Quantum Control

III. Local Control

Conclusions &
Outlook

Principle: for cracking a black box in one shot

- input : **product** of superpositions
- output: superposition of products (**entangled**)

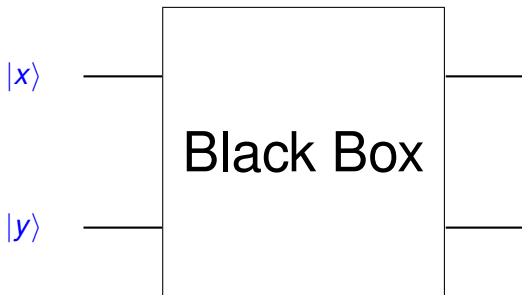



Quantum Systems – as a New Computational Resource

0. Quantum
Compiler

I. Quantum
Information

Quantum Basics
Quantum Computing

II. Quantum Control

III. Local Control

Conclusions &
Outlook

Principle: for cracking a black box in one shot

- input : **product** of superpositions
- output: superposition of products (**entangled**)





Quantum Systems – as a New Computational Resource

Example

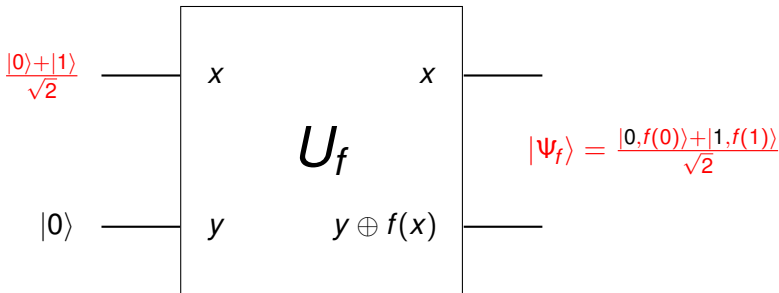

superposition of $|0\rangle, |1\rangle \mapsto$ superposition of $f(0), f(1)$

$f(0) = f(1)$ ('**constant**') \Rightarrow output '**product state**'

$f(0) \neq f(1)$ ('**balanced**') \Rightarrow output '**entangled state**'



Hadamard's Gate

- Auxiliary Single-Qubit Gate H :

$$|0\rangle \xrightarrow{H} \frac{|0\rangle + |1\rangle}{\sqrt{2}} \quad (\text{symmetric})$$

$$|1\rangle \xrightarrow{H} \frac{|0\rangle - |1\rangle}{\sqrt{2}} \quad (\text{anti-symmetric})$$

$$\text{thus } H = \frac{1}{\sqrt{2}} \begin{pmatrix} 1 & 1 \\ 1 & -1 \end{pmatrix}$$

0. Quantum Compiler

I. Quantum Information

Quantum Basics
Quantum Computing

II. Quantum Control

III. Local Control

Conclusions & Outlook



Deutsch's Algorithm

- **Task:** Decide whether **unknown** 'black-box function'
 $f : \{0, 1\} \rightarrow \{0, 1\}$ with $x \mapsto f(x)$
is **constant:** $f(0) = f(1)$, or **balanced:** $f(0) \neq f(1)$.

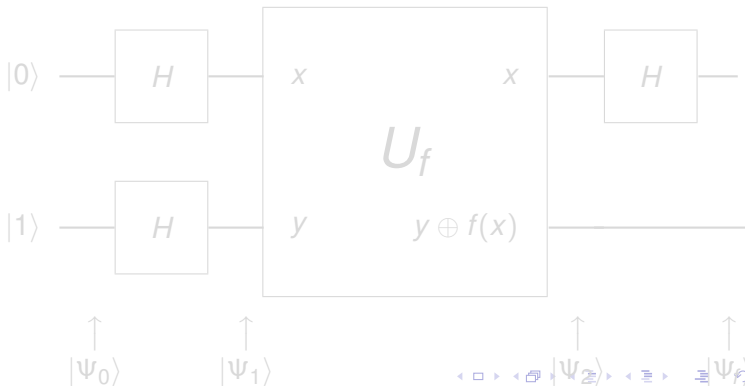



Deutsch's Algorithm

- **Task:** Decide whether **unknown** 'black-box function'
 $f : \{0, 1\} \rightarrow \{0, 1\}$ with $x \mapsto f(x)$
is **constant:** $f(0) = f(1)$, or **balanced:** $f(0) \neq f(1)$.

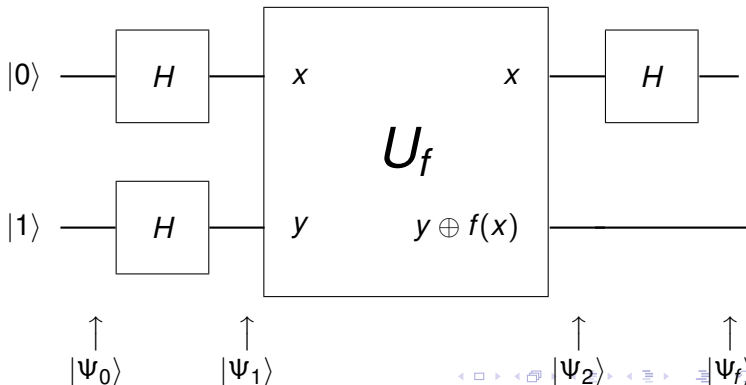

0. Quantum Compiler

I. Quantum Information

Quantum Basics
Quantum Computing

II. Quantum Control

III. Local Control

Conclusions & Outlook

Deutsch's Algorithm, Ctd

$$\blacksquare |\Psi_0\rangle \xrightarrow{H_{1,2}} |\Psi_1\rangle \xrightarrow{U_f} |\Psi_2\rangle \xrightarrow{H_1} |\Psi_f\rangle$$

$$|\Psi_0\rangle = |0\rangle_x |1\rangle_y$$

$$|\Psi_1\rangle = \frac{|0\rangle_x + |1\rangle_x}{\sqrt{2}} \frac{|0\rangle_y - |1\rangle_y}{\sqrt{2}}$$

$$|\Psi_2\rangle = \begin{cases} \pm \frac{|0\rangle_x + |1\rangle_x}{\sqrt{2}} \frac{|0\rangle_y - |1\rangle_y}{\sqrt{2}} & \text{for } f(0) = f(1) \\ \pm \frac{|0\rangle_x - |1\rangle_x}{\sqrt{2}} \frac{|0\rangle_y - |1\rangle_y}{\sqrt{2}} & \text{for } f(0) \neq f(1) \end{cases}$$

$$|\Psi_f\rangle = \pm |f(0) \oplus f(1)\rangle_x \frac{|0\rangle_y - |1\rangle_y}{\sqrt{2}}$$

$$\blacksquare \text{constant } f: f(0) \oplus f(1) = 0$$

$$\blacksquare \text{balanced } f: f(0) \oplus f(1) = 1$$

Deutsch's Algorithm, Ctd

$$\blacksquare |\Psi_0\rangle \xrightarrow{H_{1,2}} |\Psi_1\rangle \xrightarrow{U_f} |\Psi_2\rangle \xrightarrow{H_1} |\Psi_f\rangle$$

$$|\Psi_0\rangle = |0\rangle_x |1\rangle_y$$

$$|\Psi_1\rangle = \frac{|0\rangle_x + |1\rangle_x}{\sqrt{2}} \frac{|0\rangle_y - |1\rangle_y}{\sqrt{2}}$$

$$|\Psi_2\rangle = \begin{cases} \pm \frac{|0\rangle_x + |1\rangle_x}{\sqrt{2}} \frac{|0\rangle_y - |1\rangle_y}{\sqrt{2}} & \text{for } f(0) = f(1) \\ \pm \frac{|0\rangle_x - |1\rangle_x}{\sqrt{2}} \frac{|0\rangle_y - |1\rangle_y}{\sqrt{2}} & \text{for } f(0) \neq f(1) \end{cases}$$

$$|\Psi_f\rangle = \pm |f(0) \oplus f(1)\rangle_x \frac{|0\rangle_y - |1\rangle_y}{\sqrt{2}}$$

$$\blacksquare \text{constant } f: f(0) \oplus f(1) = 0$$

$$\blacksquare \text{balanced } f: f(0) \oplus f(1) = 1$$

Deutsch's Algorithm, Ctd

$$\blacksquare |\Psi_0\rangle \xrightarrow{H_{1,2}} |\Psi_1\rangle \xrightarrow{U_f} |\Psi_2\rangle \xrightarrow{H_1} |\Psi_f\rangle$$

$$|\Psi_0\rangle = |0\rangle_x |1\rangle_y$$

$$|\Psi_1\rangle = \frac{|0\rangle_x + |1\rangle_x}{\sqrt{2}} \frac{|0\rangle_y - |1\rangle_y}{\sqrt{2}}$$

$$|\Psi_2\rangle = \begin{cases} \pm \frac{|0\rangle_x + |1\rangle_x}{\sqrt{2}} \frac{|0\rangle_y - |1\rangle_y}{\sqrt{2}} & \text{for } f(0) = f(1) \\ \pm \frac{|0\rangle_x - |1\rangle_x}{\sqrt{2}} \frac{|0\rangle_y - |1\rangle_y}{\sqrt{2}} & \text{for } f(0) \neq f(1) \end{cases}$$

$$|\Psi_f\rangle = \pm |f(0) \oplus f(1)\rangle_x \frac{|0\rangle_y - |1\rangle_y}{\sqrt{2}}$$

$$\blacksquare \text{constant } f: f(0) \oplus f(1) = 0$$

$$\blacksquare \text{balanced } f: f(0) \oplus f(1) = 1$$

Deutsch's Algorithm, Ctd

$$\blacksquare |\Psi_0\rangle \xrightarrow{H_{1,2}} |\Psi_1\rangle \xrightarrow{U_f} |\Psi_2\rangle \xrightarrow{H_1} |\Psi_f\rangle$$

$$|\Psi_0\rangle = |0\rangle_x |1\rangle_y$$

$$|\Psi_1\rangle = \frac{|0\rangle_x + |1\rangle_x}{\sqrt{2}} \frac{|0\rangle_y - |1\rangle_y}{\sqrt{2}}$$

$$|\Psi_2\rangle = \begin{cases} \pm \frac{|0\rangle_x + |1\rangle_x}{\sqrt{2}} \frac{|0\rangle_y - |1\rangle_y}{\sqrt{2}} & \text{for } f(0) = f(1) \\ \pm \frac{|0\rangle_x - |1\rangle_x}{\sqrt{2}} \frac{|0\rangle_y - |1\rangle_y}{\sqrt{2}} & \text{for } f(0) \neq f(1) \end{cases}$$

$$|\Psi_f\rangle = \pm |f(0) \oplus f(1)\rangle_x \frac{|0\rangle_y - |1\rangle_y}{\sqrt{2}}$$

■ **constant** f : $f(0) \oplus f(1) = 0$

■ **balanced** f : $f(0) \oplus f(1) = 1$



Deutsch's Algorithm, Ctd

$$\blacksquare |\Psi_0\rangle \xrightarrow{H_{1,2}} |\Psi_1\rangle \xrightarrow{U_f} |\Psi_2\rangle \xrightarrow{H_1} |\Psi_f\rangle$$

$$|\Psi_0\rangle = |0\rangle_x |1\rangle_y$$

$$|\Psi_1\rangle = \frac{|0\rangle_x + |1\rangle_x}{\sqrt{2}} \frac{|0\rangle_y - |1\rangle_y}{\sqrt{2}}$$

$$|\Psi_2\rangle = \begin{cases} \pm \frac{|0\rangle_x + |1\rangle_x}{\sqrt{2}} \frac{|0\rangle_y - |1\rangle_y}{\sqrt{2}} & \text{for } f(0) = f(1) \\ \pm \frac{|0\rangle_x - |1\rangle_x}{\sqrt{2}} \frac{|0\rangle_y - |1\rangle_y}{\sqrt{2}} & \text{for } f(0) \neq f(1) \end{cases}$$

$$|\Psi_f\rangle = \pm |f(0) \oplus f(1)\rangle_x \frac{|0\rangle_y - |1\rangle_y}{\sqrt{2}}$$

■ **constant** f : $f(0) \oplus f(1) = 0$

■ **balanced** f : $f(0) \oplus f(1) = 1$



Deutsch's Algorithm, Ctd

$$\blacksquare |\Psi_0\rangle \xrightarrow{H_{1,2}} |\Psi_1\rangle \xrightarrow{U_f} |\Psi_2\rangle \xrightarrow{H_1} |\Psi_f\rangle$$

$$|\Psi_0\rangle = |0\rangle_x |1\rangle_y$$

$$|\Psi_1\rangle = \frac{|0\rangle_x + |1\rangle_x}{\sqrt{2}} \frac{|0\rangle_y - |1\rangle_y}{\sqrt{2}}$$

$$|\Psi_2\rangle = \begin{cases} \pm \frac{|0\rangle_x + |1\rangle_x}{\sqrt{2}} \frac{|0\rangle_y - |1\rangle_y}{\sqrt{2}} & \text{for } f(0) = f(1) \\ \pm \frac{|0\rangle_x - |1\rangle_x}{\sqrt{2}} \frac{|0\rangle_y - |1\rangle_y}{\sqrt{2}} & \text{for } f(0) \neq f(1) \end{cases}$$

$$|\Psi_f\rangle = \pm |f(0) \oplus f(1)\rangle_x \frac{|0\rangle_y - |1\rangle_y}{\sqrt{2}}$$

$$\blacksquare \text{constant } f: f(0) \oplus f(1) = 0$$

$$\blacksquare \text{balanced } f: f(0) \oplus f(1) = 1$$

Deutsch's Algorithm, Ctd

$$\blacksquare |\Psi_0\rangle \xrightarrow{H_{1,2}} |\Psi_1\rangle \xrightarrow{U_f} |\Psi_2\rangle \xrightarrow{H_1} |\Psi_f\rangle$$

$$|\Psi_0\rangle = |0\rangle_x |1\rangle_y$$

$$|\Psi_1\rangle = \frac{|0\rangle_x + |1\rangle_x}{\sqrt{2}} \frac{|0\rangle_y - |1\rangle_y}{\sqrt{2}}$$

$$|\Psi_2\rangle = \begin{cases} \pm \frac{|0\rangle_x + |1\rangle_x}{\sqrt{2}} \frac{|0\rangle_y - |1\rangle_y}{\sqrt{2}} & \text{for } f(0) = f(1) \\ \pm \frac{|0\rangle_x - |1\rangle_x}{\sqrt{2}} \frac{|0\rangle_y - |1\rangle_y}{\sqrt{2}} & \text{for } f(0) \neq f(1) \end{cases}$$

$$|\Psi_f\rangle = \pm |f(0) \oplus f(1)\rangle_x \frac{|0\rangle_y - |1\rangle_y}{\sqrt{2}}$$

$$\blacksquare \text{constant } f: f(0) \oplus f(1) = 0$$

$$\blacksquare \text{balanced } f: f(0) \oplus f(1) = 1$$



Hamiltonian Dynamics: Equations of Motion

States: $|\psi\rangle \in \mathcal{H}$, $\langle\psi|\psi\rangle=1$; operators: $H = H^\dagger \in \mathcal{B}(\mathcal{H})$,
 $\rho \in \mathcal{B}(\mathcal{H})$ with and $\rho \geq 0$, $\text{tr } \rho = 1$

■ pure quantum states: Schrödinger Equation

$$\begin{aligned} |\dot{\psi}(t)\rangle &= -iH |\psi(t)\rangle \\ |\psi(t)\rangle &= e^{-itH} |\psi(0)\rangle = U(t) |\psi(0)\rangle \end{aligned}$$

■ ensembles: Liouville-von Neumann Equation

$$\begin{aligned} \dot{\rho}(t) &= -i[H, \rho(t)] \\ \rho(t) &= U\rho(0)U^{-1} \end{aligned}$$

Hamiltonian dynamics ‘lives’ on **unitary orbit** of initial state.



Hamiltonian Dynamics: Equations of Motion

States: $|\psi\rangle \in \mathcal{H}$, $\langle\psi|\psi\rangle=1$; operators: $H = H^\dagger \in \mathcal{B}(\mathcal{H})$,
 $\rho \in \mathcal{B}(\mathcal{H})$ with and $\rho \geq 0$, $\text{tr } \rho = 1$

■ pure quantum states: Schrödinger Equation

$$\begin{aligned} |\dot{\psi}(t)\rangle &= -iH |\psi(t)\rangle \\ |\psi(t)\rangle &= e^{-itH} |\psi(0)\rangle = U(t) |\psi(0)\rangle \end{aligned}$$

■ ensembles: Liouville-von Neumann Equation

$$\begin{aligned} \dot{\rho}(t) &= -i[H, \rho(t)] \\ \rho(t) &= U\rho(0)U^{-1} \end{aligned}$$

Hamiltonian dynamics ‘lives’ on **unitary orbit** of initial state.



Hamiltonian Dynamics: Expectation Values

0. Quantum Compiler

I. Quantum Information

II. Quantum Control

Tasks

Gradient Algorithms

Timeoptimal Control

Decoherence Control

III. Local Control

Conclusions & Outlook

Expectation value of observables $B = B^\dagger \in \mathcal{B}(\mathcal{H})$:

- pure quantum states:

$$\langle B \rangle := \langle \psi | B | \psi \rangle$$

- ensembles:

$$\text{tr}(B^\dagger \rho(t)) = \text{tr}(B^\dagger U \rho_0 U^{-1})$$



Hamiltonian Dynamics: Expectation Values

0. Quantum Compiler

I. Quantum Information

II. Quantum Control

Tasks

Gradient Algorithms

Timeoptimal Control

Decoherence Control

III. Local Control

Conclusions & Outlook

Expectation value of observables $B = B^\dagger \in \mathcal{B}(\mathcal{H})$:

- pure quantum states:

$$\langle B \rangle := \langle \psi | B | \psi \rangle$$

- ensembles:

$$\text{tr}(B^\dagger \rho(t)) = \text{tr}(B^\dagger U \rho_0 U^{-1})$$



0. Quantum Compiler

I. Quantum Information

II. Quantum Control

Tasks

Gradient Algorithms

Timeoptimal Control

Decoherence Control

III. Local Control

Conclusions & Outlook

■ Bilinear Control System

$$\dot{X}(t) = \left(A + \sum_{j=1}^m u_j(t) B_j \right) X(t)$$

■ Hamiltonian dynamics (Schrödinger equation)

$$|\dot{\psi}(t)\rangle = -i \left(H_d + \sum_{j=1}^m u_j(t) H_j \right) |\psi(t)\rangle$$

- H_d : drift term
- H_j : controls
- $u_j(t)$: control amplitudes



0. Quantum Compiler

I. Quantum Information

II. Quantum Control

Tasks

Gradient Algorithms

Timeoptimal Control

Decoherence Control

III. Local Control

Conclusions & Outlook

■ Bilinear Control System

$$\dot{X}(t) = \left(A + \sum_{j=1}^m u_j(t) B_j \right) X(t)$$

■ Hamiltonian dynamics (Schrödinger equation)

$$|\dot{\psi}(t)\rangle = -i \left(H_d + \sum_{j=1}^m u_j(t) H_j \right) |\psi(t)\rangle$$

- H_d : drift term
- H_j : controls
- $u_j(t)$: control amplitudes



Principles: Optimal Quantum Control

0. Quantum Compiler

I. Quantum Information

II. Quantum Control

Tasks

Gradient Algorithms
Timeoptimal Control
Decoherence Control

III. Local Control

Conclusions & Outlook

Scope in Optimal Control:

maximise quality function **subject to** equation of motion

Scenarios:

■ Hamiltonian dynamics

notation: $U := e^{-itH}$; $\text{Ad}_U(\cdot) := U(\cdot)U^{-1}$; $\text{ad}_H(\cdot) := [H, \cdot]$

1. pure state $|\dot{\psi}\rangle = -iH |\psi\rangle \in \mathcal{H}$
2. gate $\dot{U} = -iH U \in \mathcal{U}(\mathcal{H})$
3. non-pure state $\dot{\rho} = -i \text{ad}_H(\rho) \in \mathcal{B}_1(\mathcal{H})$
4. projective gate $\dot{\text{Ad}}_U = -i \text{ad}_H \circ \text{Ad}_U \in \mathcal{U}(\mathcal{B}_1(\mathcal{H}))$

■ Master equations of dissipative dynamics

- 3'. non-pure state $\dot{\rho} = -(i \text{ad}_H + \Gamma)(\rho)$
- 4'. **contractive** map $\dot{\chi} = -(i \text{ad}_H + \Gamma) \circ \chi \in \mathcal{GL}(\mathcal{B}_1(\mathcal{H}))$



Principles: Optimal Quantum Control

Scope in Optimal Control:

maximise quality function **subject to** equation of motion

Scenarios:

- Hamiltonian dynamics

notation: $U := e^{-itH}$; $\text{Ad}_U(\cdot) := U(\cdot)U^{-1}$; $\text{ad}_H(\cdot) := [H, \cdot]$

1. pure state $|\dot{\psi}\rangle = -iH |\psi\rangle \in \mathcal{H}$
2. gate $\dot{U} = -iH U \in \mathcal{U}(\mathcal{H})$
3. non-pure state $\dot{\rho} = -i \text{ad}_H(\rho) \in \mathcal{B}_1(\mathcal{H})$
4. projective gate $\dot{\text{Ad}}_U = -i \text{ad}_H \circ \text{Ad}_U \in \mathcal{U}(\mathcal{B}_1(\mathcal{H}))$

- Master equations of dissipative dynamics

- 3'. non-pure state $\dot{\rho} = -(i \text{ad}_H + \Gamma)(\rho)$
- 4'. **contractive** map $\dot{\chi} = -(i \text{ad}_H + \Gamma) \circ \chi \in \mathcal{GL}(\mathcal{B}_1(\mathcal{H}))$

0. Quantum Compiler

I. Quantum Information

II. Quantum Control

Tasks

Gradient Algorithms
Timeoptimal Control
Decoherence Control

III. Local Control

Conclusions & Outlook



Typical Tasks in Optimal Quantum Control

0. Quantum Compiler

I. Quantum Information

II. Quantum Control

Tasks

Gradient Algorithms

Timeoptimal Control

Decoherence Control

III. Local Control

Conclusions & Outlook

1. Maximising Experimental Sensitivity:

maximise transfer amplitude $f := |\text{tr}\{C^\dagger UAU^\dagger\}|$,
subject to equation of motion

$$\dot{A} = -i\hat{H}A := -i(HA - AH)$$

Glaser, T.S.H., Sieveking, Schedletsky, Nielsen, Sørensen, Griesinger, *Science* **280** (1998), 421

2. Timeoptimal Quantum Compilation:

maximise fidelity $\text{Re tr}\{\hat{U}_G^\dagger \hat{U}(T)\}$

subject to equation of motion $\dot{\hat{U}}(t) = -i\hat{H} \circ \hat{U}(t)$

T.S.H., Spörl, Khaneja, Glaser, *Phys. Rev. A* **72** (2005), 042331

3. Quantum Compilation with Minimal Relaxative Loss:

maximise fidelity $\text{Re tr}\{\hat{U}_G^\dagger \chi(T)\}$

subject to equation of motion (now Master Equation)

$$\dot{\chi}(t) = -(i\hat{H} + \Gamma) \circ \chi(t)$$



Typical Tasks in Optimal Quantum Control

0. Quantum Compiler

I. Quantum Information

II. Quantum Control

Tasks

Gradient Algorithms

Timeoptimal Control

Decoherence Control

III. Local Control

Conclusions & Outlook

1. Maximising Experimental Sensitivity:

maximise transfer amplitude $f := |\text{tr}\{C^\dagger UAU^\dagger\}|$,
subject to equation of motion

$$\dot{A} = -i\hat{H}A := -i(HA - AH)$$

Glaser, T.S.H., Sieveking, Schedletsky, Nielsen, Sørensen, Griesinger, *Science* **280** (1998), 421

2. Timeoptimal Quantum Compilation:

maximise fidelity $\text{Re tr}\{\hat{U}_G^\dagger \hat{U}(T)\}$

subject to equation of motion $\dot{\hat{U}}(t) = -i\hat{H} \circ \hat{U}(t)$

T.S.H., Spörl, Khaneja, Glaser, *Phys. Rev. A* **72** (2005), 042331

3. Quantum Compilation with Minimal Relaxative Loss:

maximise fidelity $\text{Re tr}\{\hat{U}_G^\dagger \chi(T)\}$

subject to equation of motion (now Master Equation)

$$\dot{\chi}(t) = -(i\hat{H} + \Gamma) \circ \chi(t)$$



Typical Tasks in Optimal Quantum Control

0. Quantum Compiler

I. Quantum Information

II. Quantum Control

Tasks

Gradient Algorithms

Timeoptimal Control

Decoherence Control

III. Local Control

Conclusions & Outlook

1. Maximising Experimental Sensitivity:

maximise transfer amplitude $f := |\text{tr}\{C^\dagger UAU^\dagger\}|$,
subject to equation of motion

$$\dot{A} = -i\hat{H}A := -i(HA - AH)$$

Glaser, T.S.H., Sieveking, Schedletzky, Nielsen, Sørensen, Griesinger, *Science* **280** (1998), 421

2. Timeoptimal Quantum Compilation:

maximise fidelity $\text{Re tr}\{\hat{U}_G^\dagger \hat{U}(T)\}$

subject to equation of motion $\dot{\hat{U}}(t) = -i\hat{H} \circ \hat{U}(t)$

T.S.H., Spörl, Khaneja, Glaser, *Phys. Rev. A* **72** (2005), 042331

3. Quantum Compilation with Minimal Relaxative Loss:

maximise fidelity $\text{Re tr}\{\hat{U}_G^\dagger \chi(T)\}$

subject to equation of motion (now Master Equation)

$$\dot{\chi}(t) = -(i\hat{H} + \Gamma) \circ \chi(t)$$

[quant-ph/0609037](https://arxiv.org/abs/quant-ph/0609037)



Methods of Quantum Control

1. Gradient Flows on Unitary Group:

Principle: gradient flow on unitary group

- **General** $A, C \in \text{Mat}_n(\mathbb{C})$

set $f(U) := \text{tr}\{UAU^\dagger C\}$; $U = e^{-itH}$; $A_t := UAU^\dagger$
and $F_1(U) := \text{Re } f(U)$; and $F_2(U) := |f(U)|^2$ then

$$\text{grad-flow } \dot{U} = \text{grad } F_\nu(U) U = -G^{(\nu)} U$$

- recursive unitary transformations

$$U_{k+1}^{(\nu)} = e^{-\alpha_k^{(\nu)} G_k^{(\nu)}} U_k^{(\nu)} \quad \text{till} \quad \|G_{k+1}^{(\nu)}\|_2 \rightarrow 0$$

Science **280** (1998), 421 and *J. Global Optim.* **23** (2002), 283

0. Quantum
Compiler

I. Quantum
Information

II. Quantum Control
Tasks

Gradient Algorithms
Timeoptimal Control
Decoherence Control

III. Local Control

Conclusions &
Outlook



Methods of Quantum Control

1. Gradient Flows on Unitary Group:

Principle: gradient flow on unitary group

- **General** $A, C \in \text{Mat}_n(\mathbb{C})$

set $f(U) := \text{tr}\{UAU^\dagger C\}$; $U = e^{-itH}$; $A_t := UAU^\dagger$
and $F_1(U) := \text{Re } f(U)$; and $F_2(U) := |f(U)|^2$ then

$$\text{grad-flow } \dot{U} = \text{grad } F_\nu(U) U = -G^{(\nu)} U$$

- recursive unitary transformations

$$U_{k+1}^{(\nu)} = e^{-\alpha_k^{(\nu)} G_k^{(\nu)}} U_k^{(\nu)} \quad \text{till} \quad \|G_{k+1}^{(\nu)}\|_2 \rightarrow 0$$

Science **280** (1998), 421 and *J. Global Optim.* **23** (2002), 283

0. Quantum
Compiler

I. Quantum
Information

II. Quantum Control
Tasks

Gradient Algorithms
Timeoptimal Control
Decoherence Control

III. Local Control

Conclusions &
Outlook



Methods of Quantum Control

1. Gradient Flows on Unitary Group:

Principle: gradient flow on unitary group

- **General** $A, C \in \text{Mat}_n(\mathbb{C})$

set $f(U) := \text{tr}\{UAU^\dagger C\}$; $U = e^{-itH}$; $A_t := UAU^\dagger$
and $F_1(U) := \text{Re } f(U)$; and $F_2(U) := |f(U)|^2$ then

$$\text{grad-flow } \dot{U} = \text{grad } F_\nu(U) U = -G^{(\nu)} U$$

- **recursive unitary transformations**

$$U_{k+1}^{(\nu)} = e^{-\alpha_k^{(\nu)} G_k^{(\nu)}} U_k^{(\nu)} \quad \text{till} \quad \|G_{k+1}^{(\nu)}\|_2 \rightarrow 0$$

Science **280** (1998), 421 and *J. Global Optim.* **23** (2002), 283

0. Quantum
Compiler

I. Quantum
Information

II. Quantum Control
Tasks

Gradient Algorithms
Timeoptimal Control
Decoherence Control

III. Local Control

Conclusions &
Outlook

Examples of Quantum Control

1. Maximising Experimental Sensitivity:

- find $r_C(A)$ by gradient flow on unitary group

$A, C \in \text{Mat}_3(\mathbb{C})$

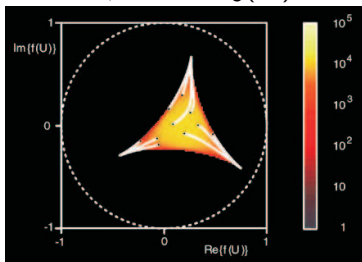

$A, C \in \text{Mat}_8(\mathbb{C})$

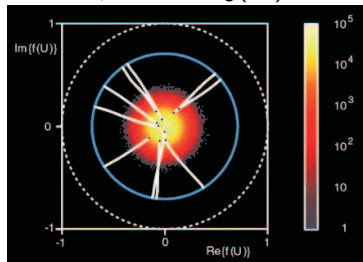

Glaser, T.S.H., Sieveking, Schedletzy, Nielsen, Sørensen, Griesinger, *Science* **280** (1998), 421

■ Gradient Ascent Algorithm GRAPE

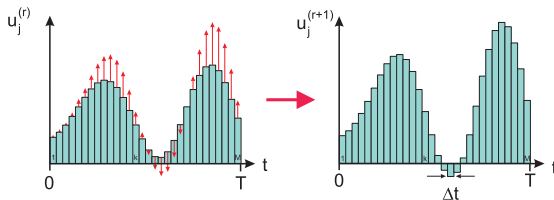

J. Magn. Reson. **172** (2005), 296 and *Phys. Rev. A* **72** (2005), 042331

Generation of Unitary Operators

The diagram illustrates the generation of unitary operators. A curved arrow starts at $U(0) = 1$ and ends at $U(T)$. Below the arrow is the equation $\dot{U} = -i H U$.

0. Quantum Compiler

I. Quantum Information

II. Quantum Control

Tasks

Gradient Algorithms

Timeoptimal Control

Decoherence Control

III. Local Control

Conclusions & Outlook



Examples of Quantum Control

2. Realising Quantum Gates in Minimal Time

Goal: *time complexity* of QFT on linear spin chain for

- Shor's algorithm
- all algorithms of (abelian) *hidden subgroup* type

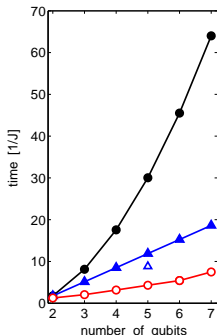
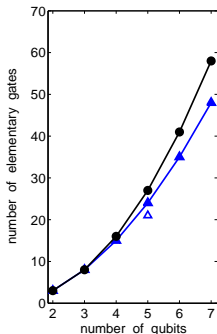

⇒ timeopt. QFT: **some 3 times faster** than fastest current standard-gate decompositions



Examples of Quantum Control

2. Realising Quantum Gates in Minimal Time

Goal: *time complexity* of C^n NOT as module in

- Quantum Error Correction

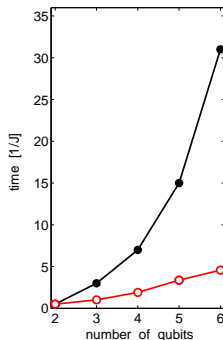
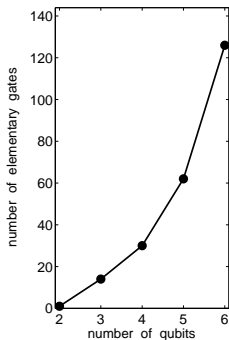

⇒ timeopt. C^n NOT: **quadratically faster** than fastest current standard-gate decomposition

0. Quantum Compiler

I. Quantum Information

II. Quantum Control

Tasks

Gradient Algorithms

Timeoptimal Control

Decoherence Control

III. Local Control

Conclusions & Outlook

Examples of Quantum Control

2. Realising Quantum Gates in Minimal Time

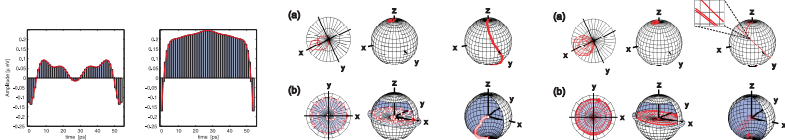

⇒ timeopt. CNOT: **some 5 times faster** than NEC group

- Quality $q := Fe^{-\tau_{\text{op}}/\tau_Q}$

so $1 - q = 1 - 0.999999999 e^{-55\text{ps}/10\text{ns}} = \mathbf{0.0055}$

(NEC: $1 - q = 1 - 0.4188 e^{-250\text{ps}/10\text{ns}} = 0.5917$)

PRA 75, 012302 (2007)



Examples of Quantum Control

2. Realising Quantum Gates in Minimal Time

0. Quantum Compiler

I. Quantum Information

II. Quantum Control

Tasks

Gradient Algorithms

Timeoptimal Control

Decoherence Control

III. Local Control

Conclusions & Outlook

Goal: TOFFOLI gate on 3 linearly coupled charge qubits

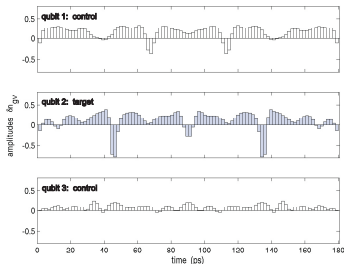

13 times faster than NEC

■ error rates cut by two orders of magnitude ($T_2 \simeq 10$ ns):

1 direct gate by optimal control

$$1 - q = 1 - 0.99999 e^{-180\text{ps}/10\text{ns}} = 0.0178$$

2 by 9 CNOT's from optimal control

$$1 - q = 1 - (0.999999999 e^{-55\text{ps}/10\text{ns}})^9 = 0.0483$$

3 by 9 CNOT's under pioneering controls

$$1 - q = 1 - (0.4188 e^{-250\text{ps}/10\text{ns}})^9 = 0.9997$$



Examples of Quantum Control

2. Realising Quantum Gates in Minimal Time

0. Quantum Compiler

I. Quantum Information

II. Quantum Control

Tasks

Gradient Algorithms

Timeoptimal Control

Decoherence Control

III. Local Control

Conclusions & Outlook

Goal: TOFFOLI gate on 3 linearly coupled charge qubits

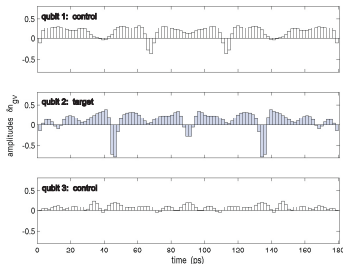

13 times faster than NEC

■ error rates cut by **two orders of magnitude** ($T_2 \simeq 10$ ns):

1 direct gate by optimal control

$$1 - q = 1 - 0.99999 e^{-180\text{ps}/10\text{ns}} = \mathbf{0.0178}$$

2 by 9 CNOT's from optimal control

$$1 - q = 1 - (0.999999999 e^{-55\text{ps}/10\text{ns}})^9 = 0.0483$$

3 by 9 CNOT's under pioneering controls

$$1 - q = 1 - (0.4188 e^{-250\text{ps}/10\text{ns}})^9 = \mathbf{0.9997}$$



Examples of Quantum Control

2. Realising Quantum Gates in Minimal Time

0. Quantum Compiler

I. Quantum Information

II. Quantum Control

Tasks

Gradient Algorithms

Timeoptimal Control

Decoherence Control

III. Local Control

Conclusions & Outlook

Goal: TOFFOLI gate on 3 linearly coupled charge qubits

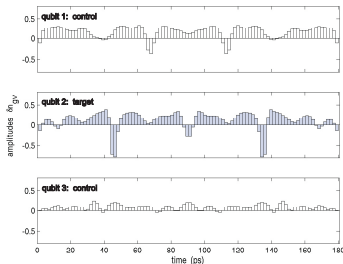

13 times faster than NEC

■ error rates cut by **two orders of magnitude** ($T_2 \simeq 10$ ns):

1 direct gate by optimal control

$$1 - q = 1 - 0.99999 e^{-180\text{ps}/10\text{ns}} = \mathbf{0.0178}$$

2 by 9 CNOT's from optimal control

$$1 - q = 1 - (0.999999999 e^{-55\text{ps}/10\text{ns}})^9 = 0.0483$$

3 by 9 CNOT's under pioneering controls

$$1 - q = 1 - (0.4188 e^{-250\text{ps}/10\text{ns}})^9 = \mathbf{0.9997}$$

Examples of Quantum Control

2. Realising Quantum Gates in Minimal Time

Goal: TOFFOLI gate on 3 linearly coupled charge qubits

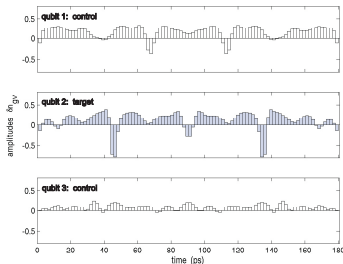

13 times faster than NEC

■ error rates cut by **two orders of magnitude** ($T_2 \simeq 10$ ns):

1 direct gate by optimal control

$$1 - q = 1 - 0.99999 e^{-180\text{ps}/10\text{ns}} = \mathbf{0.0178}$$

2 by 9 CNOT's from optimal control

$$1 - q = 1 - (0.999999999 e^{-55\text{ps}/10\text{ns}})^9 = 0.0483$$

3 by 9 CNOT's under pioneering controls

$$1 - q = 1 - (0.4188 e^{-250\text{ps}/10\text{ns}})^9 = \mathbf{0.9997}$$

0. Quantum Compiler

I. Quantum Information

II. Quantum Control

Tasks

Gradient Algorithms

Timeoptimal Control

Decoherence Control

III. Local Control

Conclusions & Outlook



Quantum Compiler

Compilation into Machine Code of Quantum Controls

0. Quantum Compiler

I. Quantum Information

II. Quantum Control

Tasks

Gradient Algorithms

Timeoptimal Control

Decoherence Control

III. Local Control

Conclusions & Outlook

■ Quantum Compilation: a Control Problem

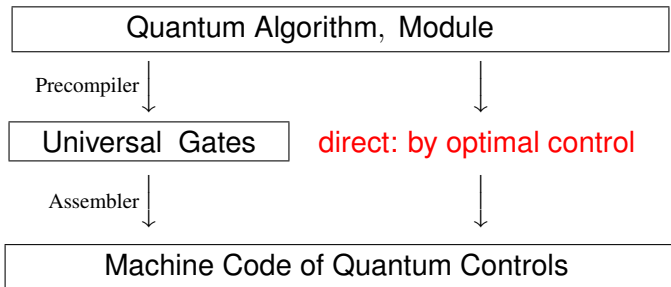

crucial for **quantum** machine code:

has to be **timeoptimal** or **decoherence protected**



Examples of Quantum Control

3. Decoherence Control: Results of System II

■ System-II: driving **outside** slowly-relaxing subspace

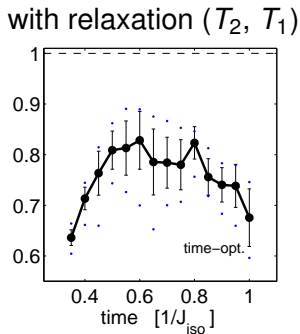
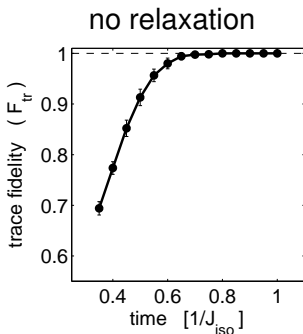

- mean of 15 time-optimised pulse sequences
- dissipation affects sequences differently

0. Quantum Compiler

I. Quantum Information

II. Quantum Control

Tasks

Gradient Algorithms

Timeoptimal Control

Decoherence Control

III. Local Control

Conclusions & Outlook

Examples of Quantum Control

3. Decoherence Control: Results of System II

■ System-II: driving **outside** slowly-relaxing subspace

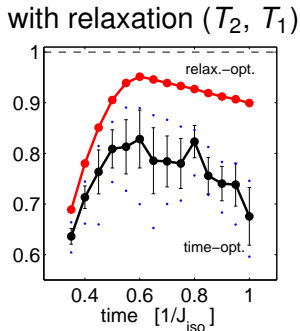
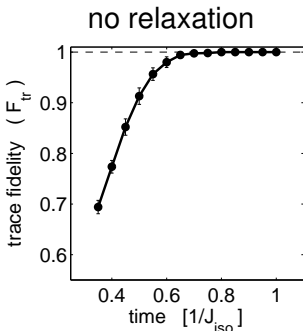

- mean of 15 time-optimised pulse sequences
- dissipation affects sequences differently
- relaxation-optimised: **systematic substantial gain**



Examples of Quantum Control

3. Realising Quantum Gates with Minimal Relaxation

CNOT under **System-II**: Projection into Subspaces

■ time-optimal

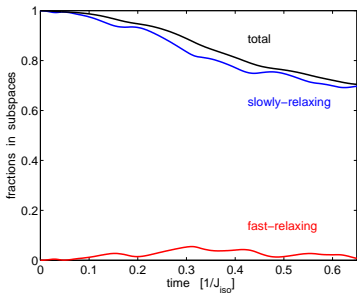

0. Quantum Compiler

I. Quantum Information

II. Quantum Control

Tasks

Gradient Algorithms

Timeoptimal Control

Decoherence Control

III. Local Control

Conclusions & Outlook



Examples of Quantum Control

3. Realising Quantum Gates with Minimal Relaxation

CNOT under **System-II**: Projection into Subspaces

■ time-optimal

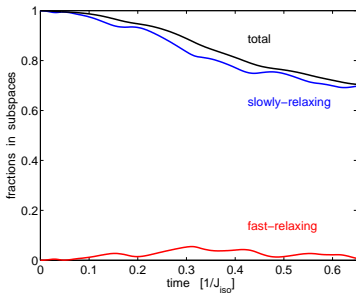

■ opt. against decoherence

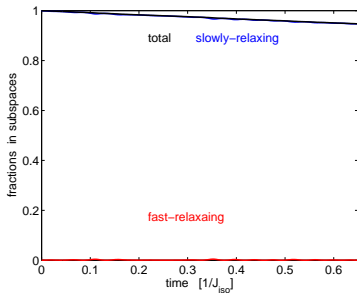

0. Quantum Compiler

I. Quantum Information

II. Quantum Control

Tasks

Gradient Algorithms

Timeoptimal Control

Decoherence Control

III. Local Control

Conclusions & Outlook

Examples of Quantum Control

3. Realising Quantum Gates with Minimal Relaxation

CNOT under **System-II**: Projection into Subspaces

■ time-optimal

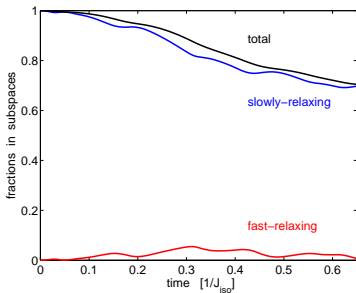

■ opt. against decoherence

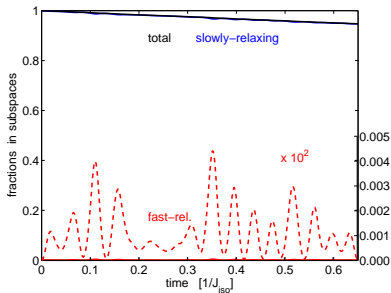



0. Quantum Compiler

I. Quantum Information

II. Quantum Control

Tasks

Gradient Algorithms

Timeoptimal Control

Decoherence Control

III. Local Control

Conclusions & Outlook

■ CNOT under **System-II**: Process Tomography of Gate Protected against Dissipation by Optimal Control

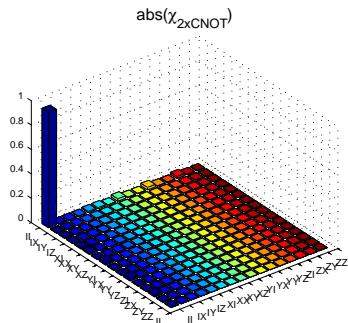
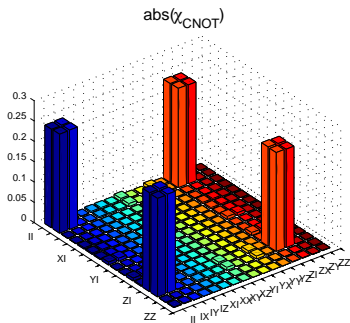



■ CNOT under **System-II**: Process Tomography of Gate Protected against Dissipation by Optimal Control

0. Quantum Compiler

I. Quantum Information

II. Quantum Control

Tasks

Gradient Algorithms

Timeoptimal Control

Decoherence Control

III. Local Control

Conclusions & Outlook

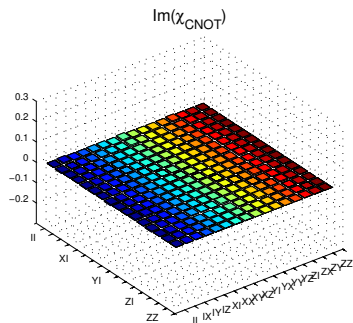
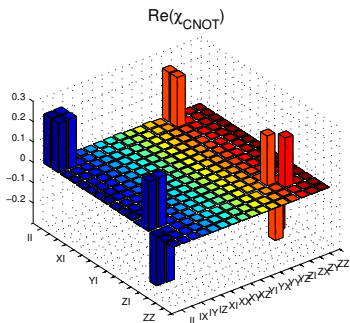

Examples of Quantum Control

3. Realising Quantum Gates with Minimal Relaxation

quant-ph/0609037

■ CNOT under **System-II**: comparison of methods

by decoherence control:
> 95% fidelity

conventional:
< 15% fidelity

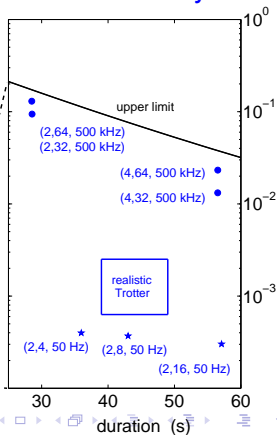
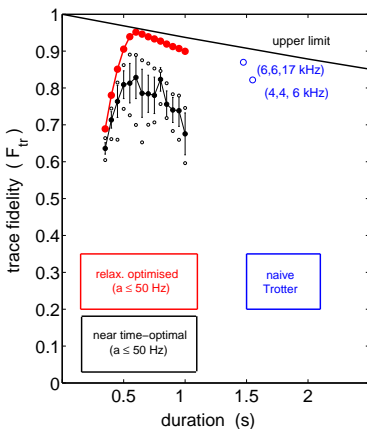

0. Quantum Compiler

I. Quantum Information

II. Quantum Control

Tasks

Gradient Algorithms

Timeoptimal Control

Decoherence Control

III. Local Control

Conclusions & Outlook



Decoherence Control: Take-Home Message

Which Tool in Which Setting?

1. *“anything goes”*: Paul FEYERABEND
only in **ideal** case: decoherence-free,
fully **controllable and closed** under drift
2. *Timeoptimal Control*:
whenever **slowly**-relaxing subsystem **controllable
and closed** under drift
3. *Relaxation-Optimised Control*:
whenever **slowly**-relaxing subsystem **open**, where
subsystem
(i) **controllable** or
(ii) **to be extended** for controllability



Decoherence Control: Take-Home Message

Which Tool in Which Setting?

1. *“anything goes”*: Paul FEYERABEND
only in **ideal** case: decoherence-**free**,
fully **controllable and closed** under drift
2. *Timeoptimal Control*:
whenever **slowly**-relaxing subsystem **controllable**
and closed under drift
3. *Relaxation-Optimised Control*:
whenever **slowly**-relaxing subsystem **open**, where
subsystem
(i) **controllable** or
(ii) **to be extended** for controllability



Decoherence Control: Take-Home Message

Which Tool in Which Setting?

1. *“anything goes”*: Paul FEYERABEND
only in **ideal** case: decoherence-free,
fully **controllable and closed** under drift
2. *Timeoptimal Control*:
whenever **slowly**-relaxing subsystem **controllable
and closed** under drift
3. *Relaxation-Optimised Control*:
whenever **slowly**-relaxing subsystem **open**, where
subsystem
 - (i) **controllable** or
 - (ii) **to be extended** for controllability



Topic III: Time-Reversal by Local Operations

Statement of the Problem

0. Quantum Compiler

I. Quantum Information

II. Quantum Control

III. Local Control

Conclusions & Outlook

Question:

Which quantum evolutions are reversible by **local** unitary operations ?

- Problem: given a Hamiltonian H and a time $t > 0$,
 $? \exists \{K_1, K_2\} \subset SU(2)^{\otimes n} : K_1 e^{-itH} K_2 = e^{+itH}$
- Equivalent to Problem: given a Hamiltonian H ,
 $? \exists \{K_1, K_2\} \subset SU(2)^{\otimes n} : K_1 H K_2 = -H$



Topic III: Time-Reversal by Local Operations

Statement of the Problem

0. Quantum Compiler

I. Quantum Information

II. Quantum Control

III. Local Control

Conclusions & Outlook

Question:

Which quantum evolutions are reversible by **local** unitary operations ?

- Problem: given a Hamiltonian H and a time $t > 0$,
 $? \exists \{K_1, K_2\} \subset SU(2)^{\otimes n} : K_1 e^{-itH} K_2 = e^{+itH}$
- Equivalent to Problem: given a Hamiltonian H ,
 $? \exists \{K_1, K_2\} \subset SU(2)^{\otimes n} : K_1 H K_2 = -H$



Topic III: Time-Reversal by Local Operations

Statement of the Problem

0. Quantum Compiler

I. Quantum Information

II. Quantum Control

III. Local Control

Conclusions & Outlook

Question:

Which quantum evolutions are reversible by **local** unitary operations ?

- Problem: given a Hamiltonian H and a time $t > 0$,
 $? \exists \{K_1, K_2\} \subset SU(2)^{\otimes n} : K_1 e^{-itH} K_2 = e^{+itH}$
- Equivalent to Problem: given a Hamiltonian H ,
 $? \exists \{K_1, K_2\} \subset SU(2)^{\otimes n} : K_1 H K_2 = -H$



Local Time-Reversal

Case Distinction

0. Quantum Compiler

I. Quantum Information

II. Quantum Control

III. Local Control

Conclusions & Outlook

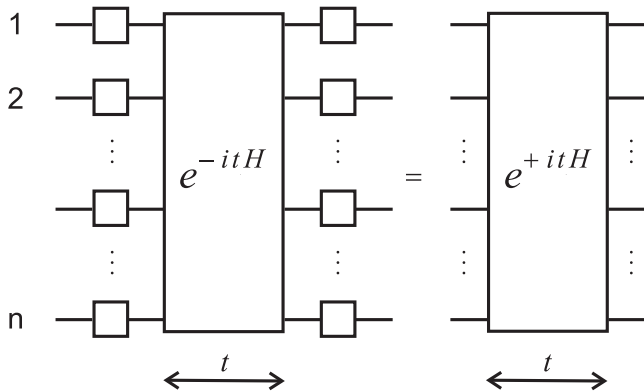

$$\text{Type-I: } K \cdot U(t) \cdot K^{-1} = U(-t) = U(t)^{-1}$$

$$\text{Type-II: } K_1 \cdot U(\tau) \cdot K_2 = U(-\tau) = U(\tau)^{-1}$$



Local Time-Reversal

Examples of Local Gradient Flows

■ Examples

- (a) ISING ZZ-interaction on cyclic graph C_4 (bipartite)
- (b) ISING ZZ-interaction on cyclic graph C_3 (not bipartite)
- (c) HEISENBERG XXX interaction (isotropic coupling)

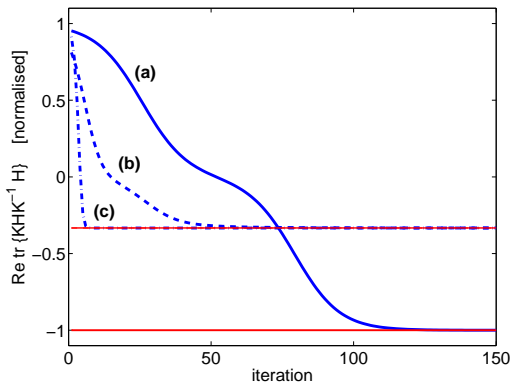



Local Time-Reversal

Examples of Local Gradient Flows

■ Examples

- (a) HEISENBERG XX -interaction on cyclic graph C_3 (not bipartite)
- (b) HEISENBERG $X(-X)$ -interaction on cyclic graph C_3

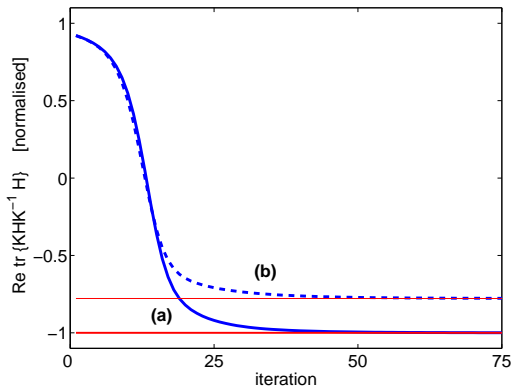



The Local C -Numerical Range

Local Quantum Control

with G. Dirr & U. Helmke

0. Quantum
Compiler

I. Quantum
Information

II. Quantum Control

III. Local Control

Conclusions &
Outlook

Definition (math-ph/0701037 and math-ph/0702005)

The *local C -numerical range* is the set

$$W_{\text{loc}}(C, A) := \{\text{tr}(C^\dagger UAU^\dagger) \mid U \in SU(2)^{\otimes n}\} \subseteq W_C(A),$$

where the unitary orbit is restricted to *local operations*
 $U =: K \in SU(2) \otimes SU(2) \otimes \cdots \otimes SU(2)$



The Local C -Numerical Range

Local Quantum Control

with G. Dirr & U. Helmke

0. Quantum Compiler

I. Quantum Information

II. Quantum Control

III. Local Control

Conclusions & Outlook

Definition (math-ph/0701037 and math-ph/0702005)

The *local C -numerical range* is the set

$$W_{\text{loc}}(C, A) := \{\text{tr}(C^\dagger UAU^\dagger) \mid U \in SU(2)^{\otimes n}\} \subseteq W_C(A),$$

where the unitary orbit is restricted to *local operations*
 $U =: K \in SU(2) \otimes SU(2) \otimes \cdots \otimes SU(2)$

Example (I non convex)

$$A := \begin{pmatrix} 1 & 0 \\ 0 & -1 \end{pmatrix} \otimes \begin{pmatrix} 1+i & 0 \\ 0 & 1-i \end{pmatrix}$$

$$C := \text{diag}(1, 0, 0, 0)$$

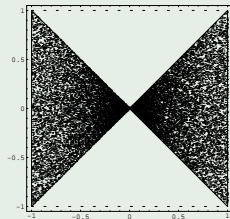



The Local C -Numerical Range

Local Quantum Control

with G. Dirr & U. Helmke

0. Quantum Compiler

I. Quantum Information

II. Quantum Control

III. Local Control

Conclusions & Outlook

Definition (math-ph/0701037 and math-ph/0702005)

The *local C -numerical range* is the set

$$W_{\text{loc}}(C, A) := \{\text{tr}(C^\dagger UAU^\dagger) \mid U \in SU(2)^{\otimes n}\} \subseteq W_C(A),$$

where the unitary orbit is restricted to *local operations*
 $U =: K \in SU(2) \otimes SU(2) \otimes \dots \otimes SU(2)$

Example (II neither star-shaped nor simply connected)

$$A := \begin{pmatrix} 1 & 0 \\ 0 & e^{2i\pi/3} \end{pmatrix}^{\otimes 3}$$

$$C := \begin{pmatrix} 1 & 0 \\ 0 & 0 \end{pmatrix}^{\otimes 3}$$

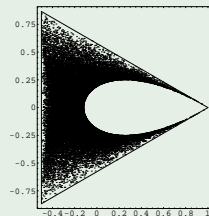



The Local C -Numerical Range

Local Quantum Control

with G. Dirr & U. Helmke

Definition (math-ph/0701037 and math-ph/0702005)

The *local C -numerical range* is the set

$$W_{\text{loc}}(C, A) := \{\text{tr}(C^\dagger UAU^\dagger) \mid U \in SU(2)^{\otimes n}\} \subseteq W_C(A),$$

where the unitary orbit is restricted to *local operations*
 $U =: K \in SU(2) \otimes SU(2) \otimes \cdots \otimes SU(2)$

Example (III distinct circular symmetry)

$$A := C := \begin{pmatrix} 0 & 0 & 0 & 0 \\ 1 & 0 & 0 & 0 \\ 1 & 0 & 0 & 0 \\ 1 & 0 & 0 & 0 \end{pmatrix}$$

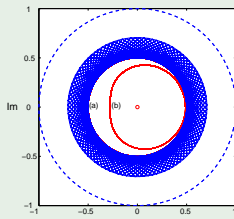

0. Quantum Compiler

I. Quantum Information

II. Quantum Control

III. Local Control

Conclusions & Outlook





Applications

Pure-State Entanglement

0. Quantum Compiler

I. Quantum Information

II. Quantum Control

III. Local Control

Conclusions & Outlook

- Maximising real part in $W_{\text{loc}}(C, A)$ minimises distance from C to *local unitary orbit* of A

$$\max_{K \in SU(2)^{\otimes n}} \text{Re tr}\{C^\dagger KAK^{-1}\} \Leftrightarrow \min_{K \in SU(2)^{\otimes n}} \|KAK^{-1} - C\|_2$$

- Application to Quantum Information Theory: let A be a given rank-1 state of the form $A = |\psi\rangle\langle\psi|$ and $C = \text{diag}(1, 0)^{\otimes n}$ [thus $W_{\text{loc}}(C, A) \rightarrow W_{\text{loc}}(A)$]

Corollary (Interpretation)

The minimal Euclidean distance is a measure of (pure-state) entanglement; i.e. it quantifies how far A is from the local equivalence class of the tensor-product state C .



Applications

Pure-State Entanglement

0. Quantum Compiler

I. Quantum Information

II. Quantum Control

III. Local Control

Conclusions & Outlook

- Maximising real part in $W_{\text{loc}}(C, A)$ minimises distance from C to *local unitary orbit* of A

$$\max_{K \in SU(2)^{\otimes n}} \operatorname{Re} \operatorname{tr}\{C^\dagger KAK^{-1}\} \Leftrightarrow \min_{K \in SU(2)^{\otimes n}} \|KAK^{-1} - C\|_2$$

- Application to Quantum Information Theory: let A be a given rank-1 state of the form $A = |\psi\rangle\langle\psi|$ and $C = \operatorname{diag}(1, 0)^{\otimes n}$ [thus $W_{\text{loc}}(C, A) \rightarrow W_{\text{loc}}(A)$]

Corollary (Interpretation)

*The minimal Euclidean distance is a **measure of (pure-state) entanglement**; i.e. it quantifies how far A is from the **local equivalence class** of the tensor-product state C .*



Applications

Pure-State Entanglement

0. Quantum Compiler

I. Quantum Information

II. Quantum Control

III. Local Control

Conclusions & Outlook

- Maximising real part in $W_{\text{loc}}(C, A)$ minimises distance from C to *local unitary orbit* of A

$$\max_{K \in SU(2)^{\otimes n}} \text{Re tr}\{C^\dagger KAK^{-1}\} \Leftrightarrow \min_{K \in SU(2)^{\otimes n}} \|KAK^{-1} - C\|_2$$

- Application to Quantum Information Theory: let A be a given rank-1 state of the form $A = |\psi\rangle\langle\psi|$ and $C = \text{diag}(1, 0)^{\otimes n}$ [thus $W_{\text{loc}}(C, A) \rightarrow W_{\text{loc}}(A)$]

Corollary (Interpretation)

The minimal Euclidean distance is a *measure of (pure-state) entanglement*; i.e. it quantifies how far A is from the *local equivalence class* of the tensor-product state C .



Applications

Pure-State Entanglement

0. Quantum Compiler

I. Quantum Information

II. Quantum Control

III. Local Control

Conclusions & Outlook

- Examples:
pure-state entanglement parameterised by s

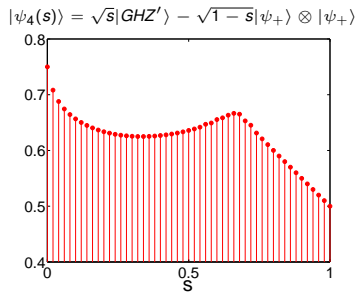
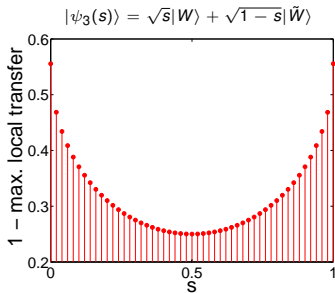



Applications

Pure-State Entanglement

0. Quantum Compiler

I. Quantum Information

II. Quantum Control

III. Local Control

Conclusions & Outlook

- CPU times: local gradient flows
very fast as compared to global techniques
- Example 1: distance to 3-qubit W state
- Example 2: distance to 4-qubit GHZ-type state

qubits	polynomial optim. cpu-time [sec] ¹	by gradient flow cpu-time [sec] ²	speed-up
3	10.92	0.30	36.4
4	103.97	0.71	147.0

¹ Eisert *et al.* (processor with 2.2 GHz, 1 GB RAM)

² average of 50 runs, Athlon XP1800+ (1.1 GHz, 512 MB RAM)



0. Quantum
Compiler

I. Quantum
Information

II. Quantum Control

III. Local Control

Conclusions &
Outlook

Corollary (Extension I: Local C -Numerical Range)

For $H = H^\dagger$ with $\|H\|_2 = 1$ the following are equivalent:

- 1 the Hamiltonian H is locally sign-reversible;
- 2 for its **local C -numerical range** $-1 \in W_{\text{loc}}(H, H)$;
- 3 its **local C -numerical range** is the interval
$$W_{\text{loc}}(H, H) = [-1; +1];$$



0. Quantum
Compiler

I. Quantum
Information

II. Quantum Control

III. Local Control

Conclusions &
Outlook

Corollary (Extension I: Local C -Numerical Range)

For $H = H^\dagger$ with $\|H\|_2 = 1$ the following are equivalent:

- 1 the Hamiltonian H is locally sign-reversible;
- 2 for its **local C -numerical range** $-1 \in W_{\text{loc}}(H, H)$;
- 3 its **local C -numerical range** is the interval
$$W_{\text{loc}}(H, H) = [-1; +1];$$



Corollary (Extension II: Lie algebras)

For $H = H^\dagger$ with $\|H\|_2 = 1$ the following are equivalent:

1 the Hamiltonian H is locally sign-reversible;

2 $\exists K \in SU(2)^{\otimes n} : \text{Ad}_K(H) = -H;$

3 H is locally unitarily similar to a \bar{H} with $\text{Ad}_{K_z}(\bar{H}) = -\bar{H};$

4 let $\mathfrak{g} = \mathfrak{g}_0 \oplus \bigoplus_{i \neq j} \mathbb{C} E_{ij}$ be the root-space

decomposition of $\mathfrak{sl}(N, \mathbb{C}); H$ is locally unitarily similar to a linear combination of root-space

elements to non-zero roots $\bar{H} := \sum_{\lambda=1}^m c_\lambda E_{ij}^{(\lambda)}$

satisfying a system of linear equations

$$\sum_\ell \rho_{\lambda,\ell} \cdot \phi_\ell = \pi \pmod{2\pi}$$



Corollary (Extension II: Lie algebras)

For $H = H^\dagger$ with $\|H\|_2 = 1$ the following are equivalent:

1 the Hamiltonian H is locally sign-reversible;

2 $\exists K \in SU(2)^{\otimes n} : \text{Ad}_K(H) = -H;$

3 H is locally unitarily similar to a \bar{H} with $\text{Ad}_{K_z}(\bar{H}) = -\bar{H};$

4 let $\mathfrak{g} = \mathfrak{g}_0 \oplus \bigoplus_{i \neq j} \mathbb{C} E_{ij}$ be the root-space

decomposition of $\mathfrak{sl}(N, \mathbb{C})$; H is locally unitarily similar to a linear combination of root-space

elements to non-zero roots $\bar{H} := \sum_{\lambda=1}^m c_\lambda E_{ij}^{(\lambda)}$

satisfying a system of linear equations

$$\sum_\ell \rho_{\lambda,\ell} \cdot \phi_\ell = \pi \pmod{2\pi}$$



Corollary (Extension II: Lie algebras)

For $H = H^\dagger$ with $\|H\|_2 = 1$ the following are equivalent:

1 the Hamiltonian H is locally sign-reversible;

2 $\exists K \in SU(2)^{\otimes n} : \text{Ad}_K(H) = -H;$

3 H is locally unitarily similar to a \bar{H} with $\text{Ad}_{K_z}(\bar{H}) = -\bar{H};$

4 let $\mathfrak{g} = \mathfrak{g}_0 \oplus \bigoplus_{i \neq j} \mathbb{C} E_{ij}$ be the root-space

decomposition of $\mathfrak{sl}(N, \mathbb{C}); H$ is locally unitarily similar to a **linear combination of root-space**

elements to non-zero roots $\bar{H} := \sum_{\lambda=1}^m c_\lambda E_{ij}^{(\lambda)}$

satisfying a system of linear equations

$$\sum_{\ell} p_{\lambda, \ell} \cdot \phi_{\ell} = \pi \pmod{2\pi}$$



Conclusions

"Show me the big effects!" Alexander PINES

0. Quantum Compiler

I. Quantum Information

II. Quantum Control

III. Local Control

Conclusions & Outlook

1 Quantum Control: key in future technology

2 Timeoptimised Quantum Compilation

- dressed to physical hardware
- access to **time complexity**
- grossly fighting decoherence

3 Decoherence-Minimising Quantum Control

- progress towards controllability under dissipation

4 Local Time Reversal

- Hamiltonian simulation
- Hahn's spin echo by local controls

5 Local Optimisation

- pure-state entanglement
- new: local C -numerical range



Conclusions

"Show me the big effects!" Alexander PINES

- 1 Quantum Control: key in future technology
- 2 Timeoptimised **Quantum Compilation**
 - dressed to physical hardware
 - access to **time complexity**
 - grossly fighting decoherence
- 3 **Decoherence-Minimising Quantum Control**
 - progress towards controllability under dissipation
- 4 Local Time Reversal
 - Hamiltonian simulation
 - Hahn's spin echo by local controls
- 5 Local Optimisation
 - pure-state entanglement
 - new: local C -numerical range

0. Quantum Compiler

I. Quantum Information

II. Quantum Control

III. Local Control

Conclusions & Outlook



Conclusions

"Show me the big effects!" Alexander PINES

0. Quantum Compiler

I. Quantum Information

II. Quantum Control

III. Local Control

Conclusions & Outlook

- 1 Quantum Control: key in future technology
- 2 Timeoptimised **Quantum Compilation**
 - dressed to physical hardware
 - access to **time complexity**
 - grossly fighting decoherence
- 3 **Decoherence-Minimising Quantum Control**
 - progress towards controllability under dissipation
- 4 Local Time Reversal
 - Hamiltonian simulation
 - Hahn's spin echo by local controls
- 5 Local Optimisation
 - pure-state entanglement
 - new: local C -numerical range



Conclusions

"Show me the big effects!" Alexander PINES

- 1 Quantum Control: key in future technology
- 2 Timeoptimised **Quantum Compilation**
 - dressed to physical hardware
 - access to **time complexity**
 - grossly fighting decoherence
- 3 **Decoherence-Minimising Quantum Control**
 - progress towards controllability under dissipation
- 4 Local Time Reversal
 - Hamiltonian simulation
 - Hahn's spin echo by local controls
- 5 Local Optimisation
 - pure-state entanglement
 - new: local **C-numerical range**

0. Quantum Compiler

I. Quantum Information

II. Quantum Control

III. Local Control

Conclusions & Outlook



Conclusions

"Show me the big effects!" Alexander PINES

0. Quantum Compiler

I. Quantum Information

II. Quantum Control

III. Local Control

Conclusions & Outlook

- 1 Quantum Control: key in future technology
- 2 Timeoptimised **Quantum Compilation**
 - dressed to physical hardware
 - access to **time complexity**
 - grossly fighting decoherence
- 3 **Decoherence-Minimising Quantum Control**
 - progress towards controllability under dissipation
- 4 Local Time Reversal
 - Hamiltonian simulation
 - Hahn's spin echo by local controls
- 5 Local Optimisation
 - pure-state entanglement
 - new: local C -numerical range



Outlook

Compilation by Recursion for Large Systems

- 0. Quantum Compiler
- I. Quantum Information
- II. Quantum Control
- III. Local Control
- Conclusions & Outlook

- recursive use of **optimised medium-sized building blocks**

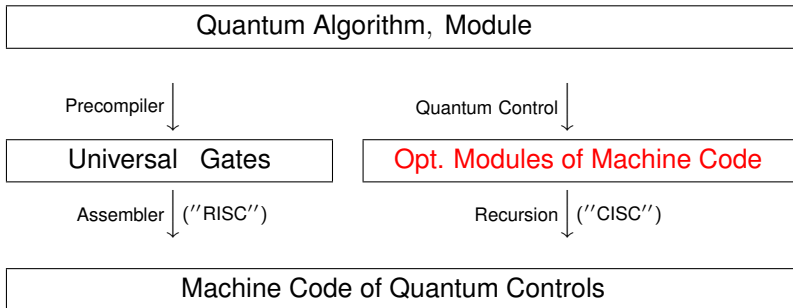



Recursion

Ex.: Recursive QFT

0. Quantum Compiler

I. Quantum Information

II. Quantum Control

III. Local Control

Conclusions & Outlook

■ **Principle:** from 2-qubit QFT to $2n$ -qubit QFT

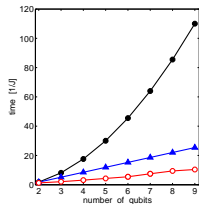
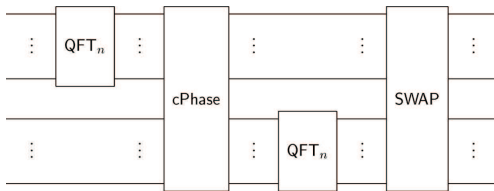
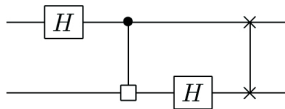



Parallelisation

Speed-Up on High-Performance Parallel Cluster with T. Gradl, T. Huckle

0. Quantum Compiler

I. Quantum Information

II. Quantum Control

III. Local Control

Conclusions & Outlook

■ Parallelising Matrix Operations

1. slice-wise:

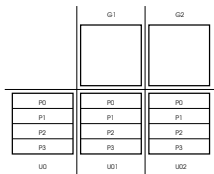

2. tree-like:

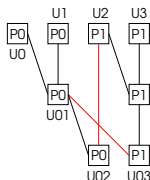

■ Resulting Speed-Ups: 10 spins 128 time slices

128 AMD Opteron 850 CPU (2.4 GHz)

Subroutine	% of time	Speedup
optimizeCG	100	578
maxStepSize	90	709
getGradient	9.1	187
expm	7.5	879
propagation	1	31
gradient	0.6	81



Acknowledgements

Thanks go to:

Andreas Spörl
Gunther Dirr, Uwe Helmke
Frank Wilhelm, Markus Storcz, Johannes Ferber, Ville Bergholm
Tobias Gradl, Thomas Huckle
Navin Khaneja
Steffen J. Glaser

integrated EU programme QAP
initial steps: QIV

References:

J. Magn. Reson. **172**, 296 (2005), *PRA* **72**, 043221 (2005),
EUROPAR Lect. Notes Comput. Sci. **4128**, 751 (2006), *PRA* **75**, 012302 (2007),
[quant-ph/0609037](#), [quant-ph/0610061](#), [quant-ph/0612165](#),
[math-ph/0701035](#), [math-ph/0702005](#)

0. Quantum
Compiler

I. Quantum
Information

II. Quantum Control

III. Local Control

Conclusions &
Outlook



2007-04-03

<http://www.informatik.tu-muenchen.de/ITEM?cmd=geta&aid=348>

#1

Stellenangebot

Studentische Hilfskraft für die Pflege und Wartung eines Softwarepakets "Parallele Matrixoperationen" auf dem HLRB-II Cluster im Rahmen eines EU-Projekts

Erforderliche Kenntnisse:

C++, MPI, UNIX/LINUX; Vordiplom

Nützlich:

Erfahrung mit Parallelrechner, Kenntnisse in Matlab

Projektbeschreibung:

Im Rahmen eines EU-Projekts: Pflege eines bestehenden Softwarepakets zur Lösung ambitionierter Optimierungsprobleme unter massiver Verwendung parallelisierter einfacher Matrixoperationen.

Die Programme laufen derzeit auf dem Infiniband-Cluster am Lehrstuhl Bode und am HLRB-II.

Dauer:

10-20 Std. pro Woche, 1 Semester mit Verlängerungsoption und Erfolgsprämie

Beginn:

Sofort oder sobald wie möglich

Kontakt:

Prof. Thomas Huckle, 02.05.044, huckle@in.tum.de